

1.2A, 1.4MHz High Efficiency Synchronous DC-DC Buck Converter AP3407/A

General Description

The AP3407/A is a 1.4MHz fixed frequency, current mode, PWM synchronous buck (step-down) DC-DC converter, capable of driving a 1.2A load with high efficiency, excellent line and load regulation. The device integrates synchronous P-channel and N-channel power MOSFET switches with low on-resistance. It is ideal for powering portable equipment that runs from a single Li-ion battery.

A standard series of inductors are available from several different manufacturers optimized for use with the AP3407/A. This feature greatly simplifies the design of switch-mode power supplies.

The AP3407/A is available in SOT-23-5.

Features

- Input Voltage Range: 2.5V to 5.5V
- Output Voltage: 0.6V to V_{IN}
- ADJ Output
- Fixed 1.4MHz Frequency
- High Efficiency up to 95%
- Output Current: 1.2A
- Current Mode Control
- 100% Duty Cycle in Dropout
- Built-in Over Current Protection
- Built-in Short Circuit Protection
- Built-in Thermal Shutdown Protection
- Built-in UVLO Function
- Built-in Soft-start

Applications

- Datacom
- Portable Device
- Smart Phone

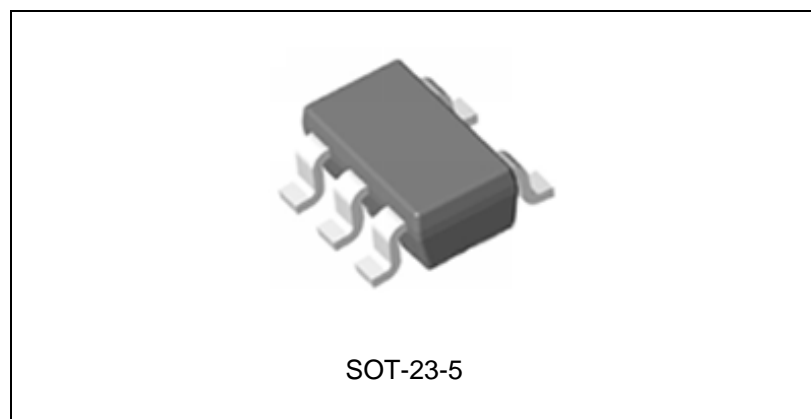
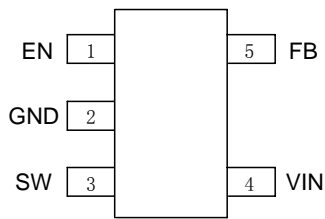

Figure 1. Package Type of AP3407/A

1.2A, 1.4MHz High Efficiency Synchronous DC-DC Buck Converter AP3407/A

Pin Configuration

K Package
(SOT-23-5)



(For AP3407)

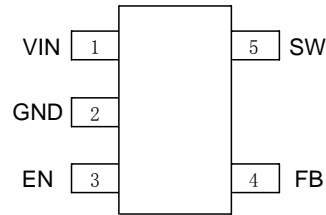

(For AP3407A)

Figure 2. Pin Configuration of AP3407/A (Top View)

Pin Description

Pin Number		Pin Name	Function
AP3407	AP3407A		
1	3	EN	Control input pin. Forcing this pin above 1.5V enables the IC. Forcing this pin below 0.4V shuts down the IC. When the IC is in shutdown mode, all functions are disabled to decrease the supply current below 1.2A
2	2	GND	Ground pin
3	5	SW	Power switch output pin. Inductor connection to drain of the internal PFET and NFET switches
4	1	VIN	Supply input pin. Bypass to GND with a 4.7μF or greater ceramic capacitor
5	4	FB	This is the feedback pin of the device. Connect this pin directly to the output if the fixed output voltage version is used. For the adjustable version an external resistor divider is connected to this pin.

1.2A, 1.4MHz High Efficiency Synchronous DC-DC Buck Converter AP3407/A

Functional Block Diagram

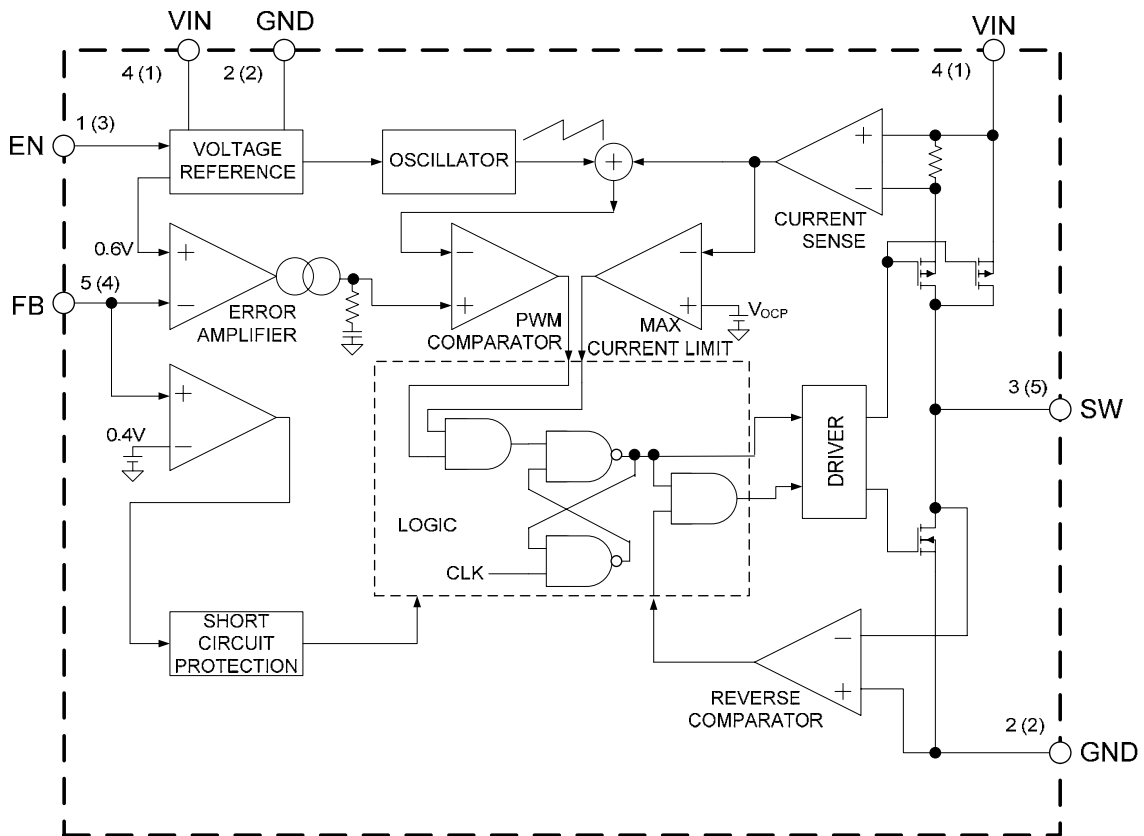

A (B)
 A for AP3407
 B for AP3407A

Figure 3. Functional Block Diagram of AP3407/A

1.2A, 1.4MHz High Efficiency Synchronous DC-DC Buck Converter AP3407/A

Ordering Information

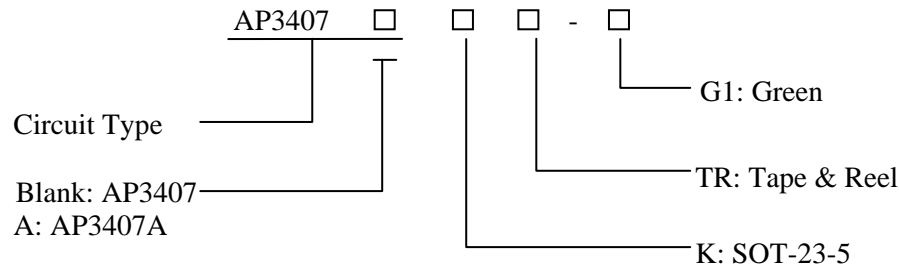

Package	Temperature Range	Part Number	Marking ID	Packing Type
		Green	Green	
SOT-23-5	-40 to 85 °C	AP3407KTR-G1	GJA	Tape & Reel
		AP3407AKTR-G1	GJB	Tape & Reel

BCD Semiconductor's Pb-free products, as designated with "G1" suffix in the part number, are RoHS compliant and green.

Absolute Maximum Ratings (Note 1)

Parameter	Symbol	Value	Unit
Input Voltage	V_{IN}	-0.3 to 6.0	V
Feedback Voltage	V_{FB}	-0.3 to $V_{IN} + 0.3$	V
EN Pin Voltage	V_{EN}	-0.3 to $V_{IN} + 0.3$	V
SW Pin Voltage	V_{SW}	-0.3 to $V_{IN} + 0.3$	V
Thermal Resistance	θ_{JA}	265	°C/W
Thermal Resistance	θ_{JC}	60	°C/W
Power Dissipation	P_D	0.377	W
Operating Junction Temperature	T_J	150	°C
Storage Temperature	T_{STG}	-65 to 150	°C
Lead Temperature (Soldering, 10sec)	T_{LEAD}	260	°C

Note 1: Stresses greater than those listed under “Absolute Maximum Ratings” may cause permanent damage to the device. These are stress ratings only, and functional operation of the device at these or any other conditions beyond those indicated under “Recommended Operating Conditions” is not implied. Exposure to “Absolute Maximum Ratings” for extended periods may affect device reliability.

Note 2: The junction temperature rise is given by $T_{RISING} = P_D * \theta_{JA}$, where P_D is the power dissipated by regulator, θ_{JA} is the thermal resistance from junction of the die to the ambient temperature; The junction temperature, T_J is given by $T_J = T_A + T_R$, where T_A is the ambient temperature.

**1.2A, 1.4MHz High Efficiency Synchronous DC-DC Buck Converter AP3407/A****Recommended Operating Conditions**

Parameter	Symbol	Min	Max	Unit
Input Voltage	V_{IN}	2.5	5.5	V
Maximum Output Current	$I_{OUT(MAX)}$	1.2		A
Operating Ambient Temperature	T_A	-40	85	°C

Electrical Characteristics

$V_{IN}=V_{DD}=V_{PVDD}=3.3V$, $T_A=25^{\circ}C$, unless otherwise specified.

Parameters	Symbol	Conditions	Min	Typ	Max	Unit
Input Voltage	V_{IN}		2.5		5.5	V
Quiescent Current	I_Q	$V_{FB}=0.65V$		62	100	μA
Shutdown Supply Current	I_{STBY}	$V_{EN}=GND$		0.1	1	μA
Reference Voltage	V_{REF}	For Adjustable Output Voltage	0.588	0.6	0.612	V
Feedback Bias Current	I_{FB}	$V_{FB}=V_{IN}$	-0.1		0.1	μA
Output Voltage Accuracy	ΔV_{OUT}		-2		2	%
PMOSFET R_{ON}	$R_{DS(ON)_P}$	$I_{SW} = 200mA$		0.28		Ω
NMOSFET R_{ON}	$R_{DS(ON)_N}$	$I_{SW} = -200mA$		0.25		Ω
Switch Current Limit	I_{LIM}	$V_{FB}=0.55V$	1.5	2.0		A
EN Pin Threshold	V_H		1.5			V
	V_L				0.4	
UVLO Threshold	V_{UVLO}	V_{DD} Rising		2.3		V
UVLO Hysteresis	V_{HYS}			0.2		
Oscillator Frequency	f_{OSC}		1.12	1.40	1.68	MHz
Max. Duty Cycle	D_{MAX}	$V_{FB}=0V$	100			%
Min. Duty Cycle	D_{MIN}	$V_{FB}=6.5V$			0	
N-MOS SW Leakage Current		$V_{IN}=3.3V, V_{SW}=3.3V$		0.1		μA
Soft-start Time	t			1		ms
Thermal Shutdown	T_{OTSD}			160		°C
Thermal Shutdown Hysteresis	T_{HYS}			20		°C

1.2A, 1.4MHz High Efficiency Synchronous DC-DC Buck Converter AP3407/A

Typical Performance Characteristics

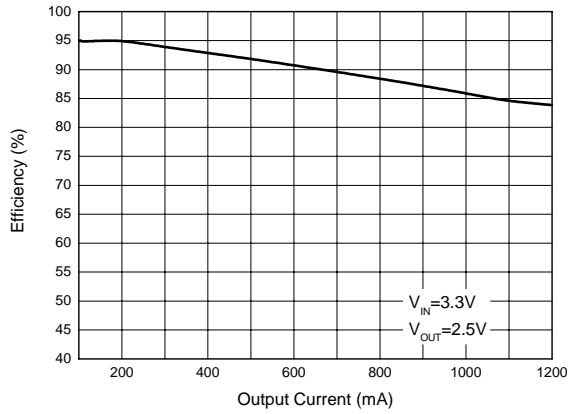

Figure 4. Efficiency vs. Output Current

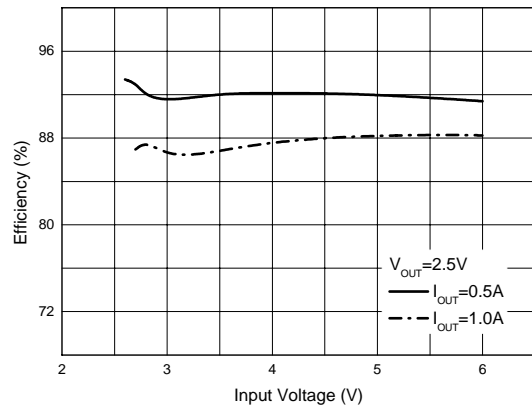

Figure 5. Efficiency vs. Input Voltage

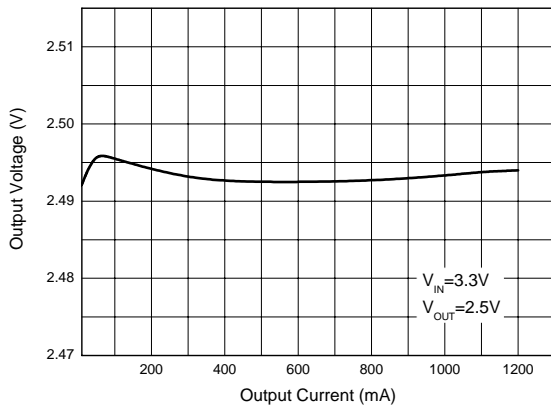

Figure 6. Output Voltage vs. Output Current

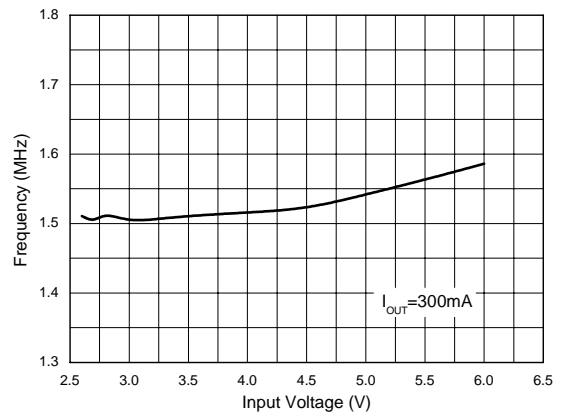

Figure 7. Frequency vs. Input Voltage

1.2A, 1.4MHz High Efficiency Synchronous DC-DC Buck Converter AP3407/A

Typical Performance Characteristics (Continued)

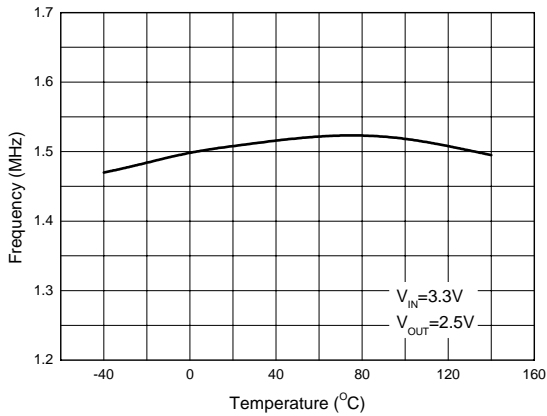

Figure 8. Frequency vs. Temperature

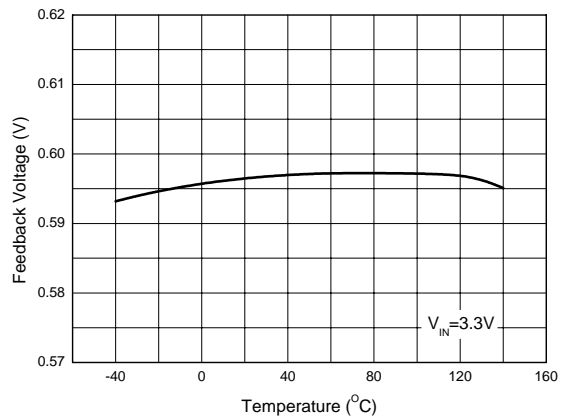

Figure 9. Feedback Voltage vs. Temperature

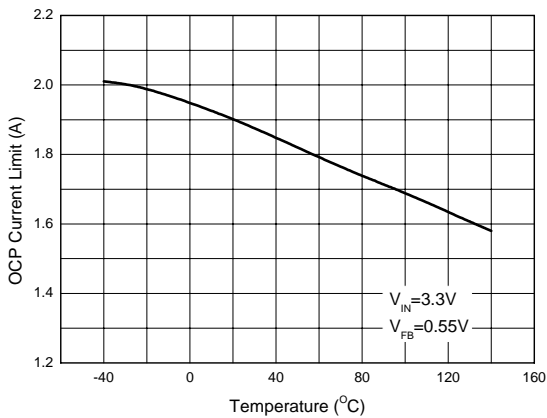

Figure 10. OCP Current Limit vs. Temperature

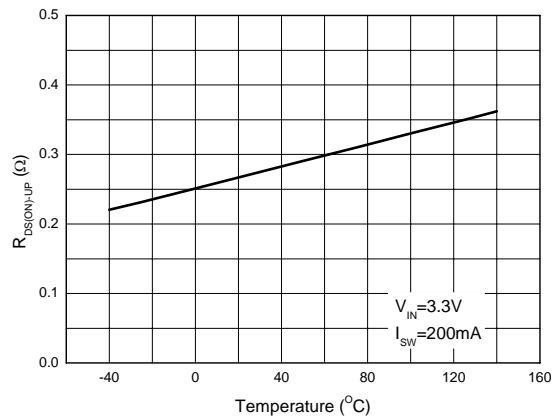
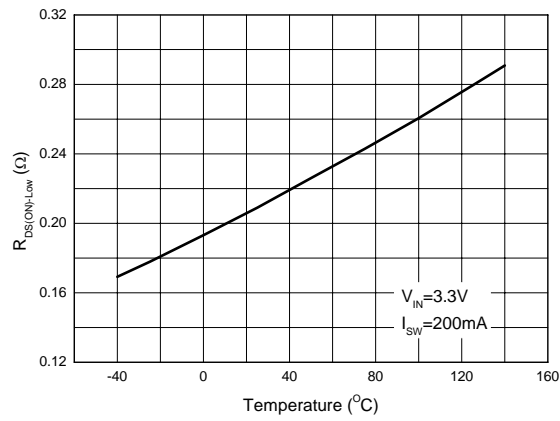

Figure 11. R_DS(ON)_UP vs. Temperature

1.2A, 1.4MHz High Efficiency Synchronous DC-DC Buck Converter AP3407/A**Typical Performance Characteristics (Continued)**Figure 12. $R_{DS(ON)_LOW}$ vs. Temperature

1.2A, 1.4MHz High Efficiency Synchronous DC-DC Buck Converter AP3407/A**Typical Application**

Figure 13. Typical Application of AP3407/A

1.2A, 1.4MHz High Efficiency Synchronous DC-DC Buck Converter AP3407/A

Mechanical Dimensions

SOT-23-5

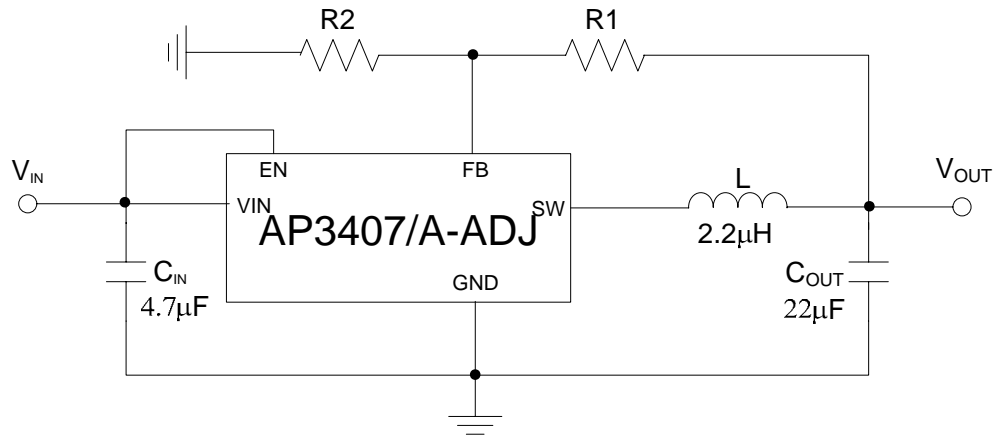
Unit: mm(inch)

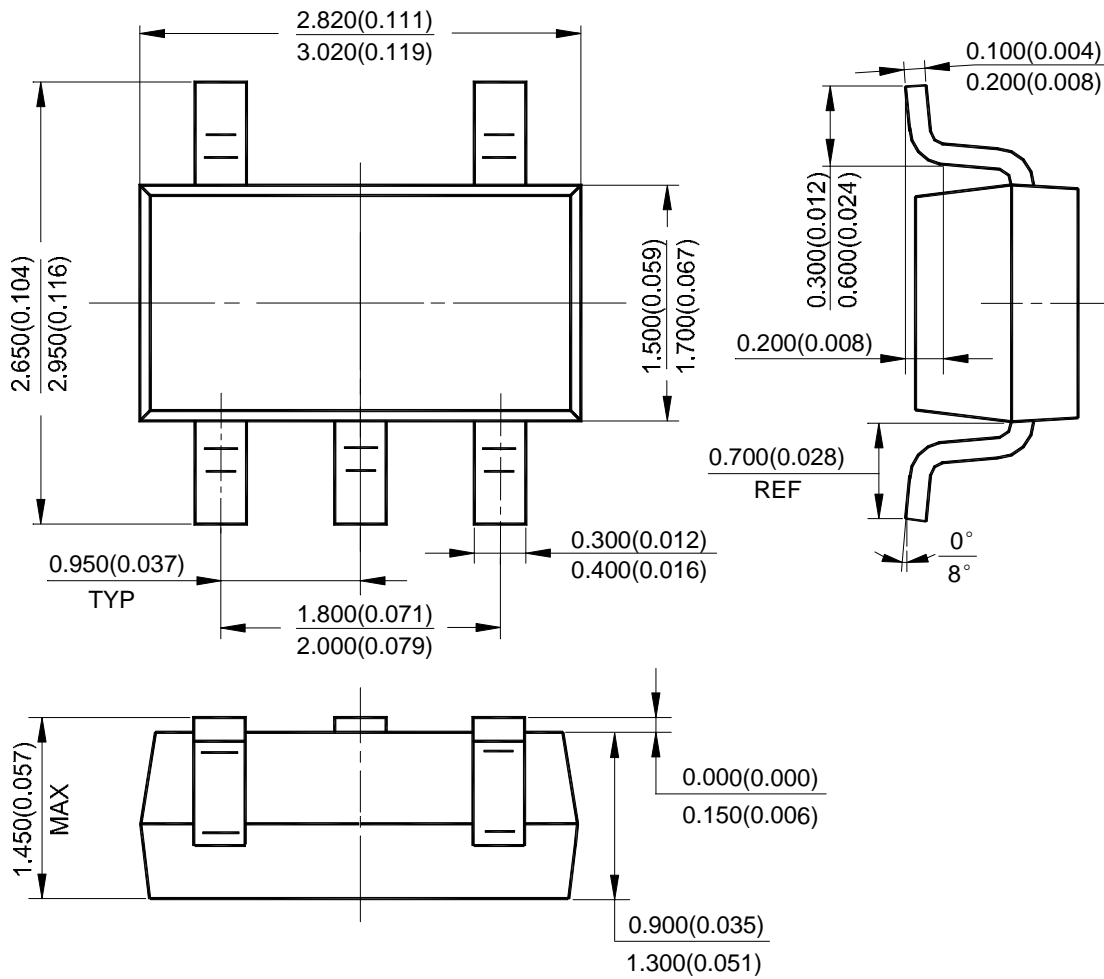



BCD Semiconductor Manufacturing Limited

<http://www.bcdsemi.com>

IMPORTANT NOTICE

BCD Semiconductor Manufacturing Limited reserves the right to make changes without further notice to any products or specifications herein. BCD Semiconductor Manufacturing Limited does not assume any responsibility for use of any its products for any particular purpose, nor does BCD Semiconductor Manufacturing Limited assume any liability arising out of the application or use of any its products or circuits. BCD Semiconductor Manufacturing Limited does not convey any license under its patent rights or other rights nor the rights of others.

MAIN SITE

- Headquarters

BCD Semiconductor Manufacturing Limited

No. 1600, Zi Xing Road, Shanghai Zizhu Science-based Industrial Park, 200241, China
Tel: +86-21-24162266, Fax: +86-21-24162277

- Wafer Fab

Shanghai SIM-BCD Semiconductor Manufacturing Co., Ltd.

800 Yi Shan Road, Shanghai 200233, China
Tel: +86-21-6485 1491, Fax: +86-21-5450 0008

REGIONAL SALES OFFICE

Shenzhen Office

Shanghai SIM-BCD Semiconductor Manufacturing Co., Ltd., Shenzhen Office

Unit A Room 1203, Skyworth Bldg., Gaoxin Ave. 1.S., Nanshan District, Shenzhen, China
Tel: +86-755-8826 7951
Fax: +86-755-8826 7865

Taiwan Office

BCD Semiconductor (Taiwan) Company Limited

4F, 298-1, Rui Guang Road, Nei-Hu District, Taipei, Taiwan
Tel: +886-2-2656 2808
Fax: +886-2-2656 2806

USA Office

BCD Semiconductor Corp.

30920 Huntwood Ave. Hayward, CA 94544, USA
Tel : +1-510-324-2988
Fax: +1-510-324-2788